

punt

ART, CRAFT & DESIGN



CORAL

TECHNICAL INFORMATION SHEET

CORAL

BY ARIK LEVY, 2023

punt

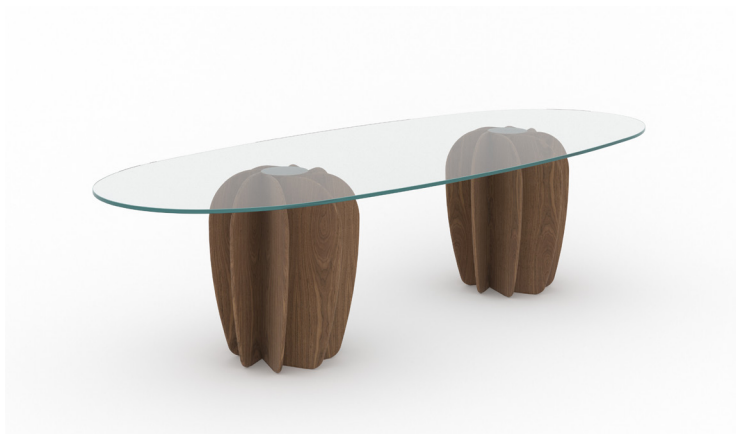

PRODUCT TYPE

Table

Coral has been conceived by the creator Arik Levy as a sculpture table capable of adapting to different uses and rooms. Its leaves or petals of organic, elegant and pure lines turn sensually forming a totem or leg that holds the oval or round top, customizable in different materials. The Coral table is available for custom orders.

TIPOLOGÍA DE PRODUCTO

Mesa alta

Coral ha sido concebida por el creador Arik Levy como una mesa escultura capaz de adaptarse a diferentes usos y estancias. Sus hojas o pétalos de líneas orgánicas, elegantes y puras giran sensualmente formando un tótem o pata que sostiene el sobre ovalado o redondo customizable en diferentes materiales. La mesa Coral está disponible para pedidos a medida.

DETAILS. DETALLES

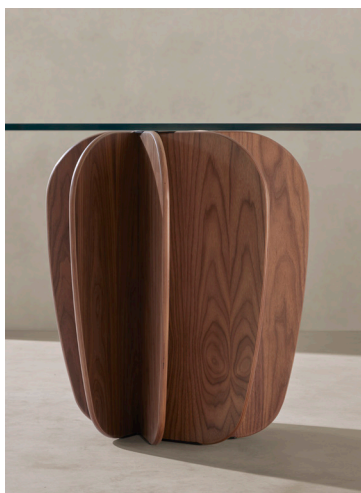

CORAL

BY ARIK LEVY, 2023

punt

DIMENSIONS. DIMENSIONES

CRL241

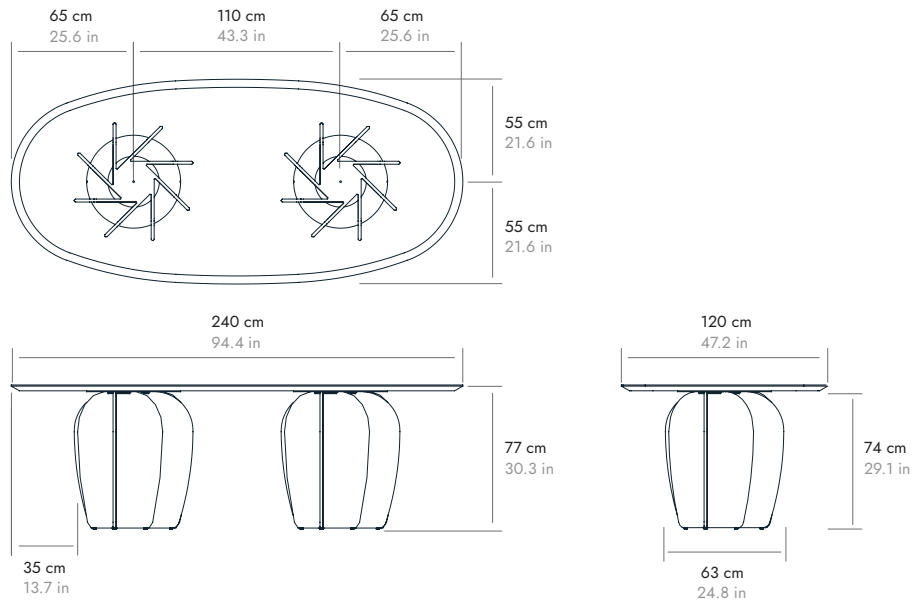

CRL301

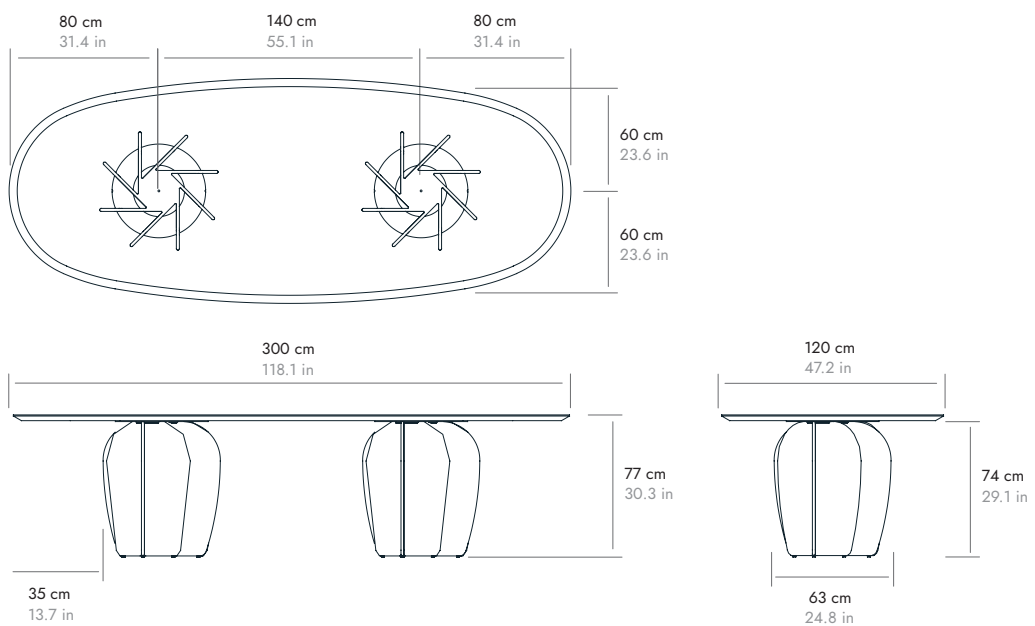

CORAL

BY ARIK LEVY, 2023

punt

SPECIAL DIMENSIONS. MEDIDAS ESPECIALES

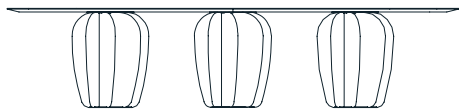
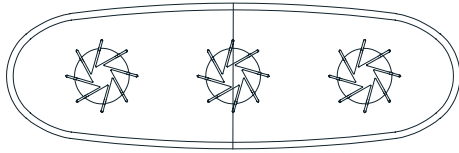

Coral table is available in special sizes upon request.
Please contact our sales department for a quotation.

La mesa Coral está disponible en medidas especiales bajo pedido.
Por favor consulte con el departamento comercial para su cotización.

COMPOSITIONS. COMPOSICIONES

CRL241175 + SEN101

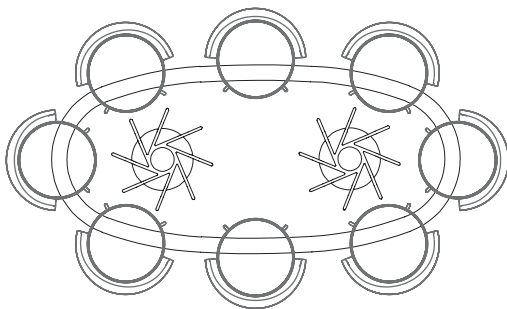

240 cm
94.4 in

CRL301275 + SEN101

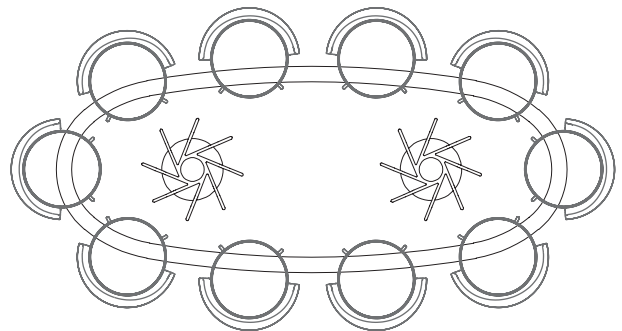

300 cm
118.1 in

ACCESORIES CORAL. ACCESORIOS CORAL

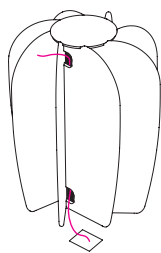

ACC087

CORAL CABLE GROMMET.

The design of this accessory embedded in the table leg allows the passage of the cable inside the totem leaving it hidden. Maximum cable space 45x60 mm.

PASACABLES CORAL.

El diseño de este accesorio incrustado en la pata de la mesa permite el paso del cable por el interior del totem dejándolo oculto. Espacio máximo para el cable 45x60 mm.

ACCESSORIES. ACCESORIOS

ACC052



Aluminum grommet to be placed on the top face of the envelope, in order to allow the passage of the cables of electronic elements and to hide them under the table.

Pasacables de aluminio para situar en la cara superior del sobre, con el objetivo de permitir el paso de los cables de elementos electrónicos y que queden ocultos bajo la mesa.

ACC036

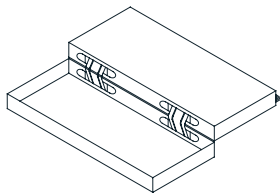

Hinged grommet embedded in the finish of the top.

Pasacables con bisagra incrustado en el acabado de la encimera.

ACC051

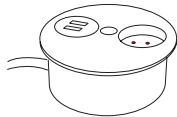

1 power sockets + 2 USB ports.

1 enchufe + 2 puertos USB.

ACC047

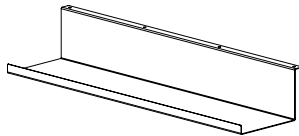

Trag. The duct is fixed on the underside of the table top, so the cables can be threaded through it.

Canaleta. El conducto se fija en la parte inferior del tablero de la mesa, de modo que los cables pueden pasarse a través de él.

ACC064

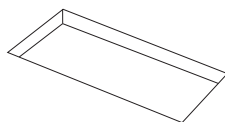

Rectangular machined hole made to measure.

Hueco rectangular mecanizado a medida.

ACC066



Circular machined hole made to measure.

Hueco circular mecanizado a medida.

ACC133

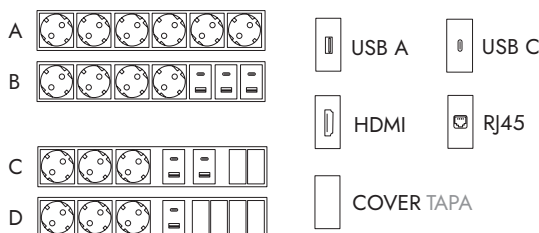

Electrifications A and B have only charging elements (plugs and USB), while electrifications C and D combine charging and multimedia elements such as RJ45, HDMI, USB A or USB C.

Las electrificaciones A y B disponen únicamente de elementos de carga (enchufes y USB), mientras que en las electrificaciones C y D se combinan los elementos de carga y multimedia como RJ45, HDMI, USB A o USB C.

CORAL

BY ARIK LEVY, 2023

punt

MATERIALS

Wood.

E1 MDF board top (low formaldehyde content) in natural walnut wood with beveled edge.

Glass.

15 mm thick tempered glass top.

Dekton.

Polished finish Dekton top.

MATERIALES

Madera.

Sobre de tablero MDF E1 (bajo contenido en formaldehído) aplacado en madera de nogal natural con canto biselado.

Vidrio.

Sobre de vidrio templado de 15 mm de espesor.

Dekton.

Sobre en Dekton acabado pulido.

Legs Patas



SUPER MATT WALNUT
NOGAL SÚPER MATE
NOYER SUPER MATE
SUPERMATT WALNUS
NOCE OPACO

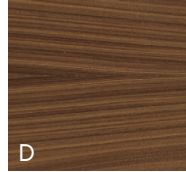

WALNUT STAINED WALNUT
NOGAL TEÑIDO NOGAL
NOYER TEINTÉ NOYER
WALNUS GEBEIZT
WALNUS
NOCE TINTO NOCE

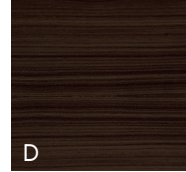

DARK STAINED WALNUT
NOGAL TEÑIDO OSCURO
NOYER TEINTÉ FONCÉ
WALNUS DUNKEL
GEBEIZT
NOCE TINTO SCURO



BLACKSTAINED WALNUT
NOGAL TEÑIDO NEGRO
NOYER TEINTÉ NOIR
WALNUS SCHWARZ
GEBEIZT
NOCE TINTO NERO

Top Sobre



SUPER MATT WALNUT
NOGAL SÚPER MATE
NOYER SUPER MATE
SUPERMATT WALNUS
NOCE OPACO

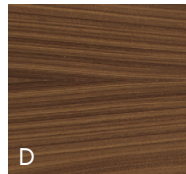

WALNUT STAINED WALNUT
NOGAL TEÑIDO NOGAL
NOYER TEINTÉ NOYER
WALNUS GEBEIZT
WALNUS
NOCE TINTO NOCE



DARK STAINED WALNUT
NOGAL TEÑIDO OSCURO
NOYER TEINTÉ FONCÉ
WALNUS DUNKEL
GEBEIZT
NOCE TINTO SCURO



BLACKSTAINED WALNUT
NOGAL TEÑIDO NEGRO
NOYER TEINTÉ NOIR
WALNUS SCHWARZ
GEBEIZT
NOCE TINTO NERO



GLASS
VIDRIO
VERRE
GLAS
VETRO

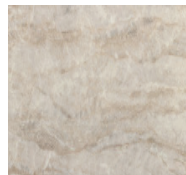

DEKTON ARGA

TOPS DETAILS. DETALLES SOBRES

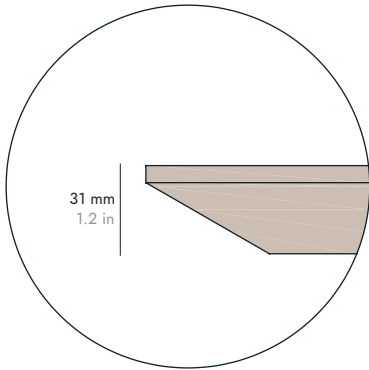

Wood. Madera

Top in 31 mm thick MDF E1 (low formaldehyde content) board, natural walnut veneer with bevelled edge.

Sobre de tablero MDF E1 (bajo contenido en formaldehído) de 31 mm de espesor, aplacado en madera de nogal natural con canto biselado.

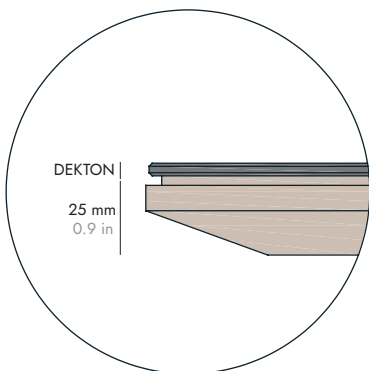

Ceramic. Porcelánico

Top composed of polished Dekton top board and a 25 mm thick bevelled bottom board of textured MDF.

Sobre compuesto por un tablero superior de Dekton acabado pulido y un tablero inferior biselado de 25 mm de espesor de MDF texturado.

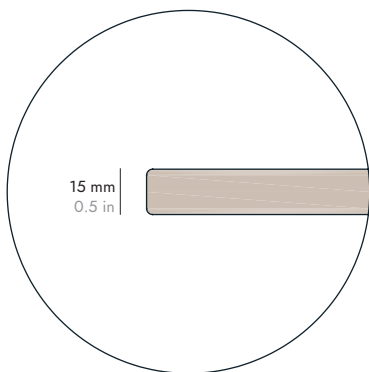

Glass. Vidrio

15 mm thick tempered glass top.

Sobre de vidrio templado de 15 mm de espesor.

Consult available finishes for each material.

Consultar acabados disponibles de cada material