

REW by Rafa García, 2014

Sistema de asientos para descansar, comer o trabajar / Sofa system for Resting, Eating or Working / Canape pour se reposer, manger ou travailler



EXPLICACION DEL MODELO

REW es el acrónimo de rest-eat-work (descansar-comer-trabajar).

Una versátil creación de **Rafa García**. El significado literal de esas palabras define a la perfección la funcionalidad de este programa modular de asientos, pues la amplia variedad de combinaciones hace posible casi cualquier configuración.

Rest (descansar). Los sillones y sofás Ly XL tienen una función muy clara: ofrecer una sentada relajada y confortable. Los cojines de decoración completan este programa, sin duda un toque hogareño que satisface la actual tendencia en proyectos contract y hospitality.

Eat (comer). La parte "nutritiva" se corresponde con un amplio abanico de bancadas, cuya altura de asiento se ha adaptado para acompañar todo tipo de mesas de comedor. Esta versión cuenta con una sola almohada tanto de asiento como respaldo que aporta un nivel de confort extra. Como novedad, hemos acortado la longitud de los brazos para facilitar su acceso.

Work (trabajar). En espacios de trabajo abiertos donde se requiere privacidad, la elevada altura de respaldos y brazos ofrece el aislamiento necesario para llevar a cabo tareas de alta concentración o mantener conversaciones en la más estricta intimidad. Además, su construcción favorece la absorción del ruido ambiente haciendo más confortable su uso en espacios de trabajo o zonas públicas.

La nueva modulación **Room** permite distribuir el espacio creando pequeñas "habitaciones" en entornos diáfanos sin necesidad de realizar obra. Las composiciones con sofás sirven para crear cómodas e informales salas para grandes oficinas y otros espacios públicos. Mientras que las modulaciones de bancadas permiten crear pequeños reservados en restaurantes y cafeterías.

La versatilidad de **REW** y su adaptabilidad a las necesidades estéticas de cada proyecto se completa con la posibilidad de incorporar dos tejidos en una misma pieza (uno para las almohadas y otro para el resto de la estructura). Además, sus patas combinan acero epoxi negro y madera de fresno que se puede tinter en todos los colores de nuestra carta.

Opcionalmente, es posible incorporar un kit de conector USB-A+C y enchufe con una amplia variedad de clavijas, un plus de flexibilidad para entornos públicos o profesionales. La clavija de conexión a la red eléctrica viene definida por el enchufe internacional seleccionado (consulta la tarifa para conocer las opciones disponibles).

REW crea un cálido y acogedor entorno y da la bienvenida a las visitas desde áreas de espera o bien se transforma en un sigiloso confidente para encuentros más privados.



DESCRIPTION

REW is an acronym for rest-eat-work.

This creation by **Rafa García** is tremendously versatile. The literal meaning of these words perfectly defines the functionality of this modular seating programme, as the wide variety of combinations makes almost any configuration possible.

Rest. The armchairs and sofas L and XL provide relaxed and comfortable seating. The decorative cushions complete this programme, undoubtedly a homey touch that meets the current trend in contract and hospitality projects.

Eat. The "nutritious" part corresponds to a wide range of benches, whose seating height has been adapted to accompany all types of dining tables. This version has a single seat and backrest cushion that provides an extra level of comfort. The arm has also been set back to aid side entry.

Work. In open workspaces where privacy is required, the high backrest and armrest provide the necessary isolation to carry out highly concentrated tasks or to converse in privacy. It is not an acoustic product itself, but its upholstered construction favours the absorption of ambient noise, making it more comfortable to use in offices or public areas.

The **Room** configurations enable efficient space distribution by creating small meeting areas in open-plan environments, without the need to resort to building work. The sofa compositions create comfortable and informal lounges for large offices and other public spaces, while the bench variants can create booths in restaurants or cafés.

REW adapts to the aesthetic needs of each project, complete with the option of incorporating two fabrics in the same piece (one for the cushions and the other for the rest of the structure). The legs are black epoxy coated steel and ash wood, which can be stained in all the colours from our chart.

An optional USB-A+C and AC socket is available, adding flexibility for public or professional environments. Each reference on the price list indicates the options that are available. The plug for the kit is defined by the type of AC socket selected.

REW creates a warm and welcoming environment for waiting areas, or a discreet hide away for private encounters.



CARACTERISTIQUES

REW signifie rest-eat-work (se reposer-manger-travailler).

Une création versatile de **Rafa García**. La signification littérale de ces mots définit à la perfection la fonctionnalité de ce programme d'assises modulables, qui peut se décliner dans une très grande variété de combinaisons et réaliser n'importe quelle configuration.

Rest (se reposer). Les fauteuils et canapés L et XL a une fonction très claire: offrir une assise relax et confortable. Les coussins de décoration complètent ce programme, sans aucun doute, une touche domestique qui répond à la tendance actuelle des projets Contract et Hôtelières.

Eat (manger). La partie nutritive est composée par un grand choix de banquettes, dont la hauteur d'assise a été adaptée pour accompagner tout type de table repas. Cette version n'a qu'un seul coussin aussi bien pour l'assise que le dossier, ce qui apporte un niveau de confort Extra. Nouveauté: nous avons raccourci la longueur des brasa fin de faciliter l'accès.

Work (travailler). Dans les espaces de travail ouverts ou la confidentialité est importante, la hauteur élevée des dossiers et des bras offre un isolement nécessaire pour mener à bien un travail de haute concentration, ou avoir des conversations dans la plus stricte intimité. De plus sa construction favorise l'absorption du bruit ambiant, rendant plus confortable son utilisation dans des espaces de travail ou des zones publiques.

La nouvelle modulation **Room** permet de distribuer l'espace en créant des petites "pièces" dans des environnements ouverts sans nécessiter de travaux. Les compositions avec canapés servent aussi bien pour créer des salles confortables et informelles pour les grands bureaux, que pour les espaces publics. Tandis que les modulaciones de banquettes permettent de créer de petits espaces réservés dans des restaurants ou cafés.

La versatilité de **REW** et son adaptabilité aux nécessités de chaque projet est complétée par la possibilité d'incorporer 2 tissus sur la même pièce (une pour les coussins et une pour la structure). De plus, les pieds sont en acier époxy noir et en frêne disponible dans toutes les teintes.

En option il est possible d'incorporer un kit de connexion USB-A+C et prise avec une grandes amplitudes de fiches, un plus pour la flexibilité pour des endroits publics ou professionnels. La fiche de connexion au réseau électrique est définie par la prise internationale sélectionnée (consulter le tarif pour connaître les différentes options disponibles).

REW crée un environnement chaleureux et accueillant et souhaite la bienvenue aux visiteurs de zones d'attente, ou bien se transforme en un confident discret pour des rencontres plus privées.

FIRMEZA / FIRMNESS / FERMETÉ

SUAVE
SOFT
DOUX

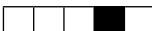

FIRME
FIRM
FERMÉ

REW by Rafa García, 2014

Sistema de asientos para descansar, comer o trabajar/ Sofa system for Resting, Eating or Working / Canape pour se reposer, manger ou travailler

IMPORTANT

Las solicitudes de composiciones modulares deben adjuntar un plano en planta al realizar el pedido. La mano (derecha/izquierda) se interpreta siempre viendo el dibujo de frente.

Por favor, no olvide indicar en el pedido el tipo de acabado deseado para las patas.

Las patas requieren montaje. Consulte las instrucciones adjuntas al producto.

Consulte www.sancal.com/care para obtener información sobre cuidado y mantenimiento.

IMPORTANT

Modular compositions should be ordered with a plan view. Left/right are interpreted when looking at the front of the sofa.

Please remember to indicate the desired type of finish for the legs on the order.

The legs require fitting, as per the instructions that are included with the piece.

Consult www.sancal.com/care for essential care and maintenance information.

IMPORTANT

Les commandes de compositions modulables doivent être accompagnées d'un plan avec les dessins toujours vue de face.

Ne pas oublier non plus d'indiquer le type de finition désiré pour les pieds.

Les pieds sont livrés démontés. Voir instructions de montage.

Visitez www.sancal.com/care pour plus d'informations sur la sécurité et l'entretien.

CARACTERISTICAS TECNICAS**TELA Y PIEL**

- Estructura y almohadas totalmente desenfundables.
- Asiento: tubo de acero F1 pintado epoxi negro con tablero de partículas, recubierto de espuma CMHR 35kg y funda con velour.
- Respaldos y brazos altos: estructura de tablero de partículas, recubierto de espuma CMHR 30 kg y funda con velour, fijado mediante pletinas de acero F1 imprimado pintado epoxi negro.
- Brazo bajo: estructura de pino y tablero de partículas, recubierto de espuma CMHR 30kg y funda con velour, fijado mediante pletinas de acero F1 pintado epoxi negro.
- Patas: estructura de tubo de acero F1 pintado epoxi negro y recubiertas de madera de fresno.
- Almohada de respaldo: espuma de densidad diferenciada, recubierto de fibra poliéster H150 gr termofusionada y funda interior de malla.
- Almohada de respaldo: espuma de CM 25kg, recubierto de fibra poliéster H150 gr termofusionada y funda interior de malla.
- Cojines de decoración: funda de algodón rellena FiberDream (microfibra tacto pluma).
- Juego de placas metálicas para unir dos módulos.

Kit eléctrico:

- Longitud de cable: 2,5 metros.
- USB A + C 5A. (Carga rápida, si el dispositivo o terminal lo permite). En caso de rotura o avería, posibilidad de repuesto con cambio fácil, sin necesidad de desconectarlo de la toma eléctrica.
- Opción de enchufes internacionales.
- Montaje base enchufes con pestañas ocultas. Permite otra colocación a la sugerida.
- Carcasa de policarbonato negro retardante al fuego.
- Cumple normativas: BS5733-2010 y IEC60884-1.
- Certificaciones: UL962A/CSA22.2
- Marcado CE: para las bases de las zonas "Gran Bretaña" y "Europa".
- Base enchufe GB: Incorpora fusible en cumplimiento de la normativa BS6396.

TECHNICAL SPECIFICATIONS**FABRIC AND LEATHER**

- Removable back and cushion covers.
- Seat: black epoxy coated F1 steel covered in pressed wood covered in CMHR 35kg foam and fibre.
- High back and arms: pressed wood covered in CMHR 30kg foam with black epoxy coated F1 steel fittings.
- Low arm: solid wooden structure with a pressed wood board covered in CMHR 30kg foam and felt with black epoxy coated F1 steel fittings.
- Legs: black epoxy F1 steel covered in solid ash.
- Seat cushion: multi-density foam covered in H150g thermofused fibre and polyester netting.
- Back cushion: CM 25kg foam covered in H150g thermofused fibre and polyester netting.
- Scatter cushions: FiberDream with a cotton cover.
- Set of metallic plates to join two modules.

Electrical kit:

- Cable length: 2.5m.
- Fitted with USB A + C 5A (fast charge capable) easy to fix with a hot swap kit, sold separately.
- Range of international sockets available.
- Fire retardant black polycarbonate.
- Meets: BS5733-2010 and IEC60884-1.
- Certified by: UL962A/CSA22.2
- CE mark: for GB and Europe sockets.
- GB socket is fused as per BS6396.

CARACTERISTIQUES TECHNIQUES**TISSU ET CUIR**

- Structure et coussins 100% déhoussables.
- Assise: structure tubulaire en acier F1 peint époxy noir et panneau de particules, recouvert de mousse CMHR 35kg avec velours.
- Dossiers et bras haut: panneau de particules, recouvert de mousse CMHR 30kg avec velours, le tout fixé sur platine en acier F1 imprimé peint époxy noir.
- Bras bas: structure en pin et panneau de particules, recouvert de mousse CMHR 30kg avec velours, le tout fixé sur platine en acier F1 imprimé peint époxy noir.
- Pieds: structure tubulaire en acier F1 peint époxy noir et recouverte de bois de frêne.
- Coussin d'assise: mousses de différentes densités, recouvertes d'une fibre polyester H150gr et tissu de finition.
- Coussins de dos: mousse CM de 25kg, recouvertes d'une fibre polyester H150gr et tissu de finition.
- Coussins de décoration: housse coton garnie de fibre FiberDream (microfibre toucher plume).
- Jeu de plaques métalliques pour attacher deux modules.

Kit électrique :

- Longueur du cable: 2.5 mètres
- USB + C5A (charge rapide). En cas de casse ou de panne, possibilité de réparation avec échange facile, sans déconnexion de la prise de courant.
- Option prises de courant internationales.
- Montage base-prise avec des attaches ocultas. Permet d'autres choix d'installation que celui proposé.
- Boîtier en polycarbonate noir feu retardant.
- Conforme aux normes : BS5733-2010 et IEC60884-1.
- Certifications: UL962A/CSA22.2
- Marquage CE: pour les bases des zones « Grande Bretagne » et « Europe ».
- Base prise GB: incorpore fusible selon la norme BS6396.

TAPIZADO / UPHOLSTERED / RECOUVREMENT

Tejidos combinados
Combined fabrics
Tissus combinés

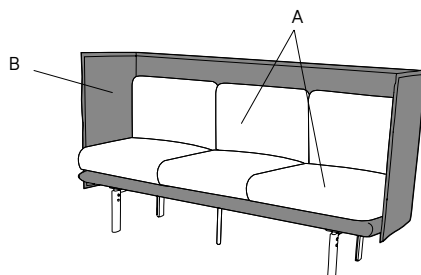

REW by Rafa García, 2014

Sistema de asientos para descansar, comer o trabajar / Sofa system for Resting, Eating or Working / Canape pour se reposer, manger ou travailler

FAMILIA
FAMILY
FAMILLE

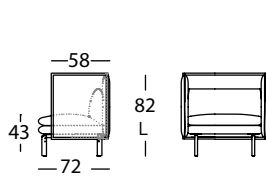

Sofás L
L Sofas
Canapés L

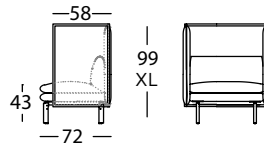

Sofás XL
XL Sofas
Canapés XL

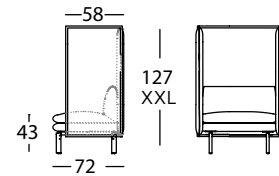

Sofás XXL
XXL Sofas
Canapés XXL

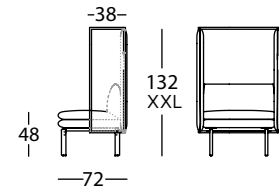

Bancadas XXL
XXL Benches
Banc XXL

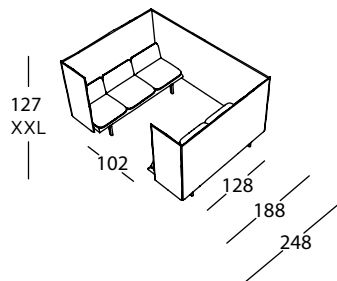

Room sofá
Room sofa
Room canapé

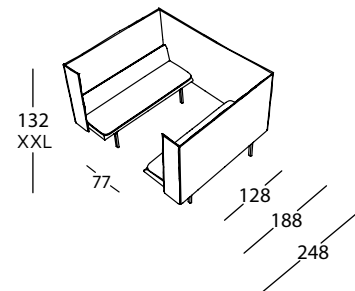

Room bancada
Room bench
Room banc

KIT ELÉCTRICO
ELECTRIC SET
KIT ÉLECTRIQUE

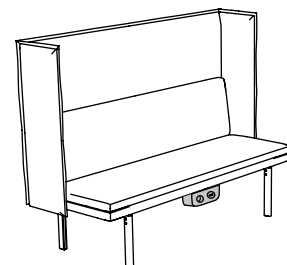
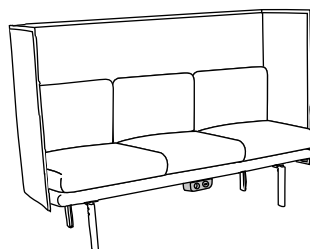
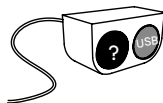

REW by Rafa García, 2014

Sofá XXL / XXL Sofa / Canapé XXL

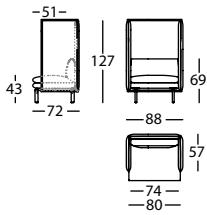
**292.11.JN.2**

REW SILLON 88 XXL
REW XXL-SIZE ARMCHAIR 88
REW FAUTEUIL 88 XXL

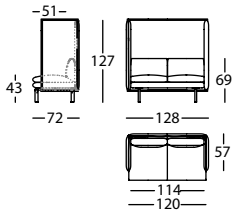
0,76 m³ / 1 Pack. / 52,0 kg**292.11.NN.2**

REW SOFA 128 XXL
REW XXL-SIZE SOFA 128
REW CANAPE 128 XXL

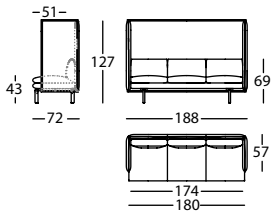
1,09 m³ / 1 Pack. / 670 kg**292.11.UN.2**

REW SOFA 188 XXL
REW XXL-SIZE SOFA 188
REW CANAPE 188 XXL

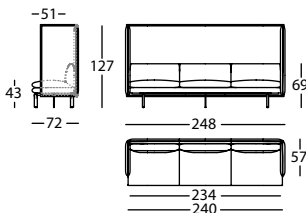
1,59 m³ / 1 Pack. / 870 kg**292.11.Z1N.2**

REW SOFA 248 XXL
REW XXL-SIZE SOFA 248
REW CANAPE 248 XXL

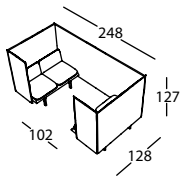
2,09 m³ / 1 Pack. / 920 kg**292.11.Z1N**

REW ROOM SOFA 248X128 XXL
REW XXL-SIZE ROOM SOFA 248X128
REW ROOM CANAPE 248X128 XXL

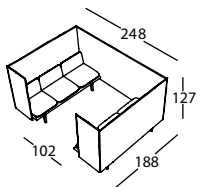
2,48 m³ / 3 Pack. / 134,0 kg**292.11.Z1U**

REW ROOM SOFA 248X188 XXL
REW XXL-SIZE ROOM SOFA 248X188
REW ROOM CANAPE 248X188 XXL

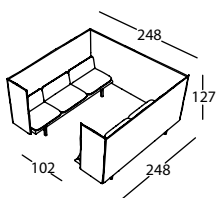
3,48 m³ / 3 Pack. / 165,7 kg**292.11.Z1Z1**

REW ROOM SOFA 248X248 XXL
REW XXL-SIZE ROOM SOFA 248X248
REW ROOM CANAPE 248X248 XXL

4,48 m³ / 3 Pack. / 199,0 kg

REW by Rafa García, 2014

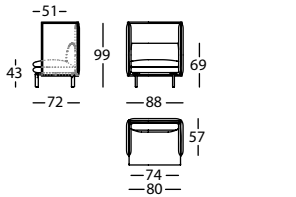
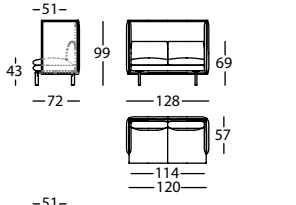
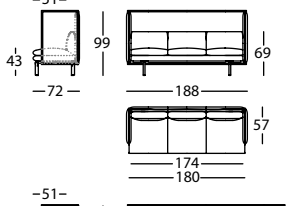
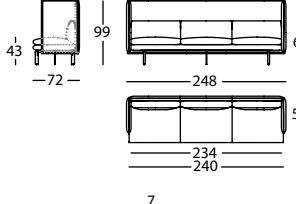
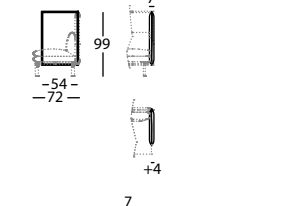
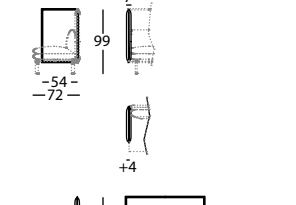
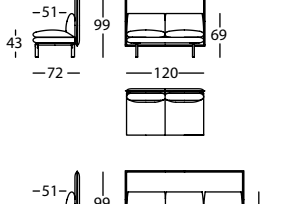
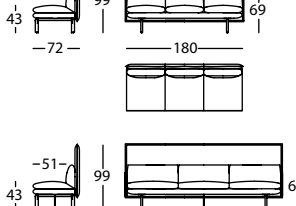
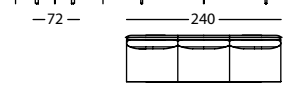

Sofás y módulos XL / XL sofas & modules / Canapés et modules XL

	<p>292.11.JK.2 REW SILLON 88 XL REW XL-SIZE ARMCHAIR 88 REW FAUTEUIL 88 XL</p> <p>0,57 m³ / 1 Pack. / 54,0 kg</p>
	<p>292.11.NK.2 REW SOFA 128 XL REW XL-SIZE SOFA 128 REW CANAPE 128 XL</p> <p>0,82 m³ / 1 Pack. / 57,0 kg</p>
	<p>292.11.UK.2 REW SOFA 188 XL REW XL-SIZE SOFA 188 REW CANAPE 188 XL</p> <p>1,20 m³ / 1 Pack. / 76,0 kg</p>
	<p>292.11.Z1K.2 REW SOFA 248 XL REW XL-SIZE SOFA 248 REW CANAPE 248 XL</p> <p>1,58 m³ / 1 Pack. / 89,0 kg</p>
	<p>292.133.K.D REW BRAZO XL DCHO REW XL-SIZE RIGHT ARM REW BRAS XL DROIT</p> <p>0,02 m³ / 1 Pack. / 8,0 kg</p>
	<p>292.133.K.I REW BRAZO XL IZDO REW XL-SIZE LEFT ARM REW BRAS XL GAUCHE</p> <p>0,02 m³ / 1 Pack. / 8,0 kg</p>
	<p>292.12.NK REW MODULO 120 XL REW XL-SIZE MODULE 120 REW MODULE 120 XL</p> <p>0,77 m³ / 1 Pack. / 38,0 kg</p>
	<p>292.12.UK REW MODULO 180 XL REW XL-SIZE MODULE 180 REW MODULE 180 XL</p> <p>1,15 m³ / 1 Pack. / 52,0 kg</p>
	<p>292.12.Z1K REW MODULO 240 XL REW XL-SIZE MODULE 240 REW MODULE 240 XL</p> <p>1,53 m³ / 1 Pack. / 73,0 kg</p>

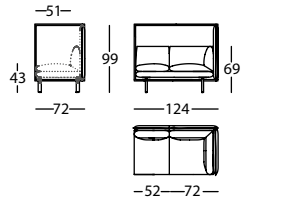
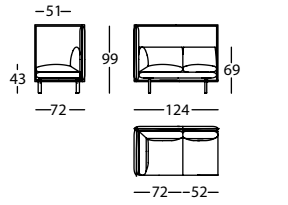
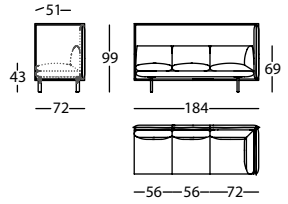
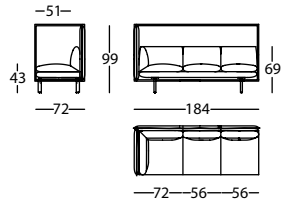
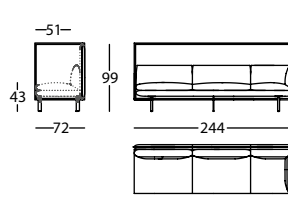
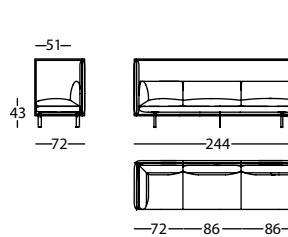
	<p>292.16.NK.D REW ANGULO DCHO 124 XL REW XL-SIZE RIGHT CORNER 124 REW ANGLE DROIT 124 XL</p> <p>0,80 m³ / 1 Pack. / 49,5 kg</p>
	<p>292.16.NK.I REW ANGULO IZDO 124 XL REW XL-SIZE LEFT CORNER 124 REW ANGLE GAUCHE 124 XL</p> <p>0,80 m³ / 1 Pack. / 49,5 kg</p>
	<p>292.16.UK.D REW ANGULO DCHO 184 XL REW XL-SIZE RIGHT CORNER 184 REW ANGLE DROIT 184 XL</p> <p>1,17 m³ / 1 Pack. / 65,2 kg</p>
	<p>292.16.UK.I REW ANGULO IZDO 184 XL REW XL-SIZE LEFT CORNER 184 REW ANGLE GAUCHE 184 XL</p> <p>1,17 m³ / 1 Pack. / 65,2 kg</p>
	<p>292.16.Z1K.D REW ANGULO DCHO 244 XL REW XL-SIZE RIGHT CORNER 244 REW ANGLE DROIT 244 XL</p> <p>1,55 m³ / 1 Pack. / 87,5 kg</p>
	<p>292.16.Z1K.I REW ANGULO IZDO 244 XL REW XL-SIZE LEFT CORNER 244 REW ANGLE GAUCHE 244 XL</p> <p>1,55 m³ / 1 Pack. / 87,5 kg</p>

EJEMPLO ANGULOS / EXAMPLE CORNER / EXEMPLE ANGLE

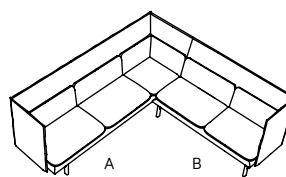

REF MOD:

A
292.16.UK.D
REW ANGULO DCHO 184 XL
REW XL-SIZE RIGHT CORNER 184
REW ANGLE DROIT 184 XL

B
292.133.K.I
REW BRAZO XL IZDO
REW XL-SIZE LEFT ARM
REW BRAS XL GAUCHE

B
292.12.NK
REW MOD 120 XL
REW XL-SIZE MODULE 120
REW MODULE 120 XL

B
292.133.K.D
REW BRAZO XL DCHO
REW XL-SIZE RIGHT ARM
REW BRAS XL DROIT

Cada uno de los brazos incluidos en esta página sólo se puede combinar con los 3 módulos referenciados a continuación de los mismos.

Each one of the arms presented on this page can only be combined with the three modules listed below them.

Chacun des bras figurant sur cette page ne peut être combiné qu'avec les 3 modules se trouvant en dessous.

----- LINEAS OCULTAS / HIDDEN LINES / LIGNES OCCULTES

REW by Rafa García, 2014

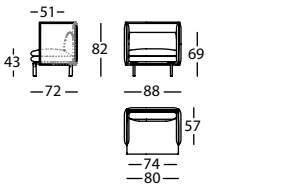
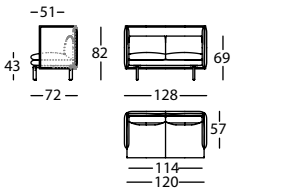
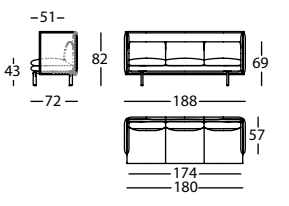
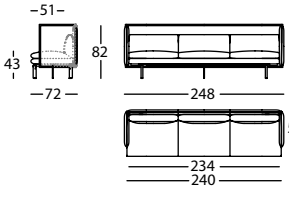
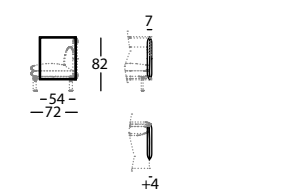
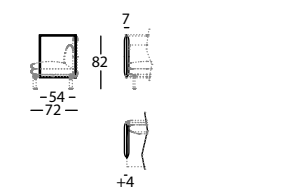
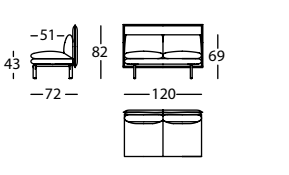
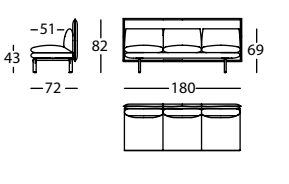
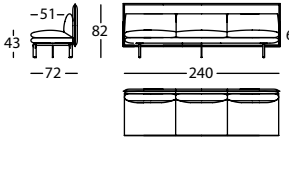

Sofás y módulos L / L sofas & modules / Canapés et modules L

	<p>292.11.JJ.2 REW SILLON 88 L REW L-SIZE ARMCHAIR 88 REW FAUTEUIL 88 L</p> <p>0,46 m³ / 1 Pack. / 41,0 kg</p>
	<p>292.11.NJ.2 REW SOFA 128 L REW L-SIZE SOFA 128 REW CANAPE 128 L</p> <p>0,66 m³ / 1 Pack. / 52,0 kg</p>
	<p>292.11.UJ.2 REW SOFA 188 L REW L-SIZE SOFA 188 REW CANAPE 188 L</p> <p>0,96 m³ / 1 Pack. / 69,0 kg</p>
	<p>292.11.Z1J.2 REW SOFA 248 L REW L-SIZE SOFA 248 REW CANAPE 248 L</p> <p>1,25 m³ / 1 Pack. / 87,0 kg</p>
	<p>292.133.J.D REW BRAZO L DCHO REW L-SIZE RIGHT ARM REW BRAS L DROIT</p> <p>0,02 m³ / 1 Pack. / 6,0 kg</p>
	<p>292.133.J.I REW BRAZO L IZDO REW L-SIZE LEFT ARM REW BRAS L GAUCHE</p> <p>0,02 m³ / 1 Pack. / 6,0 kg</p>
	<p>292.12.NJ REW MODULO 120 L REW L-SIZE MODULE 120 REW MODULE 120 L</p> <p>0,62 m³ / 1 Pack. / 36,0 kg</p>
	<p>292.12.UJ REW MODULO 180 L REW L-SIZE MODULE 180 REW MODULE 180 L</p> <p>0,92 m³ / 1 Pack. / 51,5 kg</p>
	<p>292.12.Z1J REW MODULO 240 L REW L-SIZE MODULE 240 REW MODULE 240 L</p> <p>1,21 m³ / 1 Pack. / 69,0 kg</p>

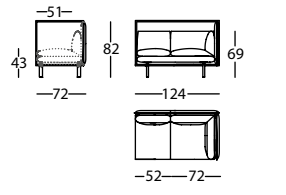
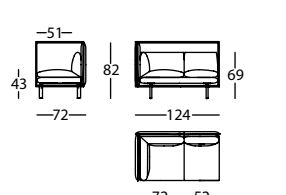
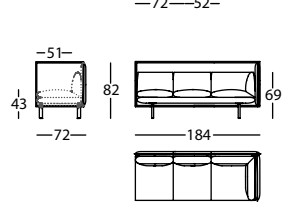
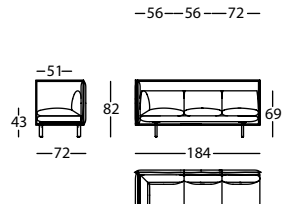
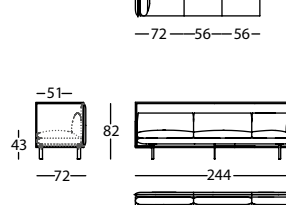
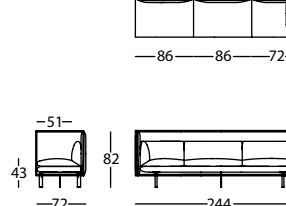
	<p>292.16.NJ.D REW ANGULO DCHO 124 L REW L-SIZE RIGHT CORNER 124 REW ANGLE DROIT 124 L</p> <p>0,64 m³ / 1 Pack. / 45,0 kg</p>
	<p>292.16.NJ.I REW ANGULO IZDO 124 L REW L-SIZE LEFT CORNER 124 REW ANGLE GAUCHE 124 L</p> <p>0,64 m³ / 1 Pack. / 45,0 kg</p>
	<p>292.16.UJ.D REW ANGULO DCHO 184 L REW L-SIZE RIGHT CORNER 184 REW ANGLE DROIT 184 L</p> <p>0,94 m³ / 1 Pack. / 61,9 kg</p>
	<p>292.16.UJ.I REW ANGULO IZDO 184 L REW L-SIZE LEFT CORNER 184 REW ANGLE GAUCHE 184 L</p> <p>0,94 m³ / 1 Pack. / 61,9 kg</p>
	<p>292.16.Z1J.D REW ANGULO DCHO 244 L REW L-SIZE RIGHT CORNER 244 REW ANGLE DROIT 244 L</p> <p>1,23 m³ / 1 Pack. / 80,5 kg</p>
	<p>292.16.Z1J.I REW ANGULO IZDO 244 L REW L-SIZE LEFT CORNER 244 REW ANGLE GAUCHE 244 L</p> <p>1,23 m³ / 1 Pack. / 80,5 kg</p>

EJEMPLO ANGULOS / EXAMPLE CORNER / EXEMPLE ANGLE

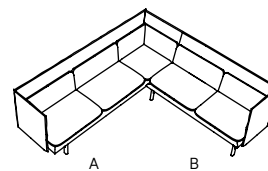

REF MOD:

A
292.16.UJ.D
REW ANGULO DCHO 184 L
REW L-SIZE RIGHT CORNER 184
REW ANGLE DROIT 184 L

B
292.133.J.I
REW BRAZO L IZDO
REW L-SIZE LEFT ARM
REW BRAS L GAUCHE

B
292.12.NJ
REW MOD 120 L
REW L-SIZE MODULE 120
REW MODULE 120 L

B
292.133.J.D
REW BRAZO L DCHO
REW L-SIZE RIGHT ARM
REW BRAS L DROIT

Cada uno de los brazos incluidos en esta página sólo se puede combinar con los 3 módulos referenciados a continuación de los mismos.

Each one of the arms presented on this page can only be combined with the three modules listed below them.

Chacun des bras figurant sur cette page ne peut être combiné qu'avec les 3 modules se trouvant en dessous.

----- LINEAS OCULTAS / HIDDEN LINES / LIGNES OCCULTES

REW by Rafa García, 2014



Bancadas XXL / XXL Benches. / Banc XXL

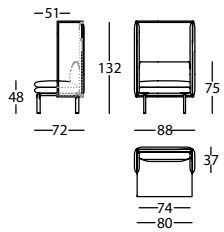

292.12.JHP

REW BANCADA 88 XXL
REW XXL-SIZE BENCH 88
REW BANC 88 XXL

0,76 m³ / 1 Pack. / 54,5 kg

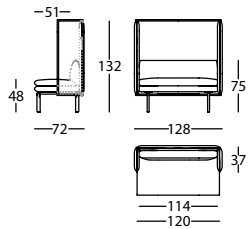

292.12.NHP

REW BANCADA 128 XXL
REW XXL-SIZE BENCH 128
REW BANC 128 XXL

1,09 m³ / 1 Pack. / 64,0 kg

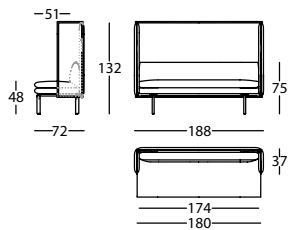

292.12.UHP

REW BANCADA 188 XXL
REW XXL-SIZE BENCH 188
REW BANC 188 XXL

1,59 m³ / 1 Pack. / 78,0 kg

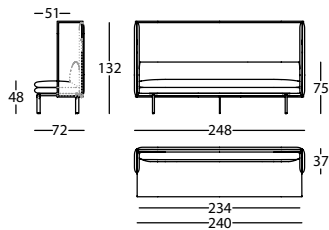

292.12.Z1HP

REW BANCADA 248 XXL
REW XXL-SIZE BENCH 248
REW BANC 248 XXL

2,09 m³ / 1 Pack. / 92,0 kg

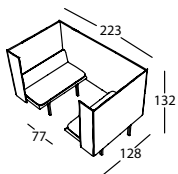

292.11.YNP

REW ROOM BANCADA 223X128 XXL
REW XXL-SIZE ROOM BENCH 223X128
REW ROOM BANC 223X128 XXL

2,45 m³ / 3 Pack. / 130,4 kg

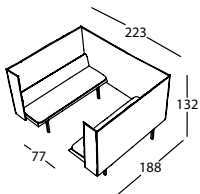

292.11.YUP

REW ROOM BANCADA 223X188 XXL
REW XXL-SIZE ROOM BENCH 223X188
REW ROOM BANC 223X188 XXL

3,44 m³ / 3 Pack. / 161,7 kg

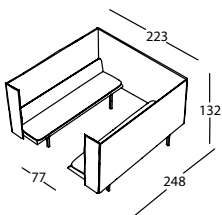

292.11.YZ1P

REW ROOM SOFÁ BANCADA 223X248 XXL
REW XXL-SIZE ROOM BENCH 223X248
REW ROOM BANC 223X248 XXL

4,44 m³ / 3 Pack. / 195,0 kg

REW by Rafa García, 2014

Sistema de asientos para descansar, comer o trabajar / Sofa system for Resting, Eating or Working / Canape pour se reposer, manger ou travailler

Composiciones recomendadas
Recommended compositions
Compositions recommandables

REW ROOM BANCADA / BENCH / BANC	DUMBBELL MESA / TABLE
------------------------------------	--------------------------

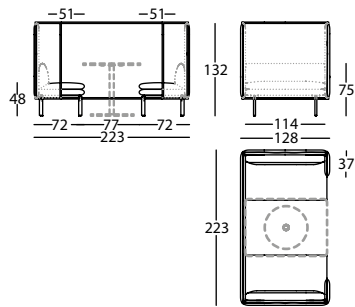

292.11.YNP

REW ROOM BANCADA 223X128 XXL
REW XXL-SIZE ROOM BENCH 223X128
REW ROOM BANC 223X128 XXL

1,79 m² / 3 Bultos / 130,4 kg

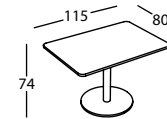
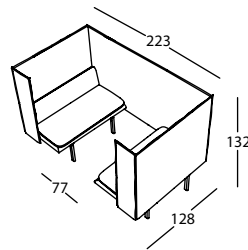

318.74.115X80X74

DUMBBELL MESA COMEDOR 115X80X74
DUMBBELL DINING TABLE 115X80X74
DUMBBELL TABLE REPAS 115X80X74

0,13 m² / 3 Bultos / 33,5 kg

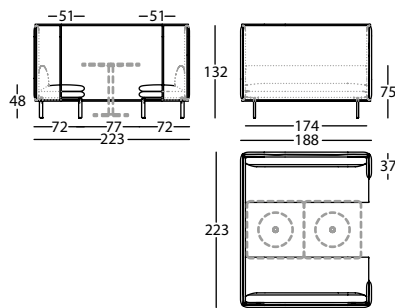

292.11.YUP

REW ROOM BANCADA 223X188 XXL
REW XXL-SIZE ROOM BENCH 223X188
REW ROOM BANC 223X188 XXL

2,54 m² / 3 Bultos / 161,7 kg

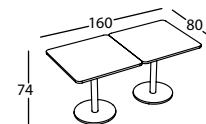
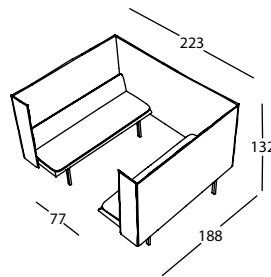

318.74.80X74 x2

DUMBBELL MESA COMEDOR 80X80X74
DUMBBELL DINING TABLE 80X80X74
DUMBBELL TABLE REPAS 80X80X74

0,10 m² / 3 Bultos / 28,4 kg

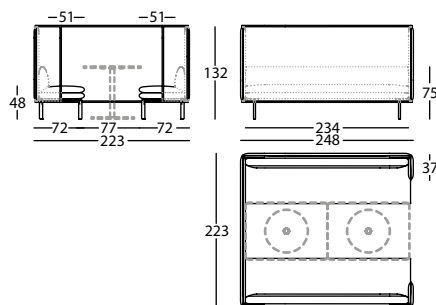

292.11.YZ1P

REW ROOM SOFÁ BANCADA 223X248 XXL
REW XXL-SIZE ROOM BENCH 223X248
REW ROOM BANC 223X248 XXL

3,29 m² / 3 Bultos / 206,3 kg

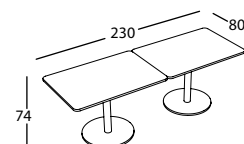
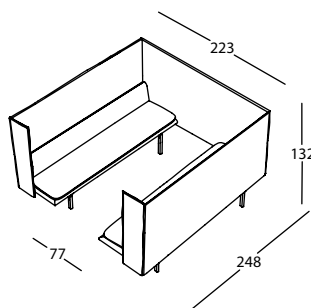

318.74.115X80X74 x2

DUMBBELL MESA COMEDOR 115X80X74
DUMBBELL DINING TABLE 115X80X74
DUMBBELL TABLE REPAS 115X80X74

0,13 m² / 3 Bultos / 33,5 kg

REW by Rafa García, 2014



Accesorios / Accessories / Accessoires



292.22.DD

REW COJIN 38X38
REW CUSHION 38X38
REW COUSSIN 38X38

0,02 m² / - Pack. / 0,7 kg

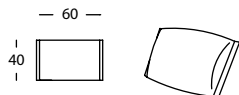

292.22.GE

REW ALMOHADA 60X40
REW CUSHION 60X40
REW COUSSIN 60X40

0,04 m² / - Pack. / 1,7 kg



292.31

REW JUEGO PLACAS UNION MODULO
REW SET OF METAL COUPLERS FOR JOINING MODULES
REW JEU DE PLAQUES D'UNION POUR MODULES

- m² / - Pack. / - kg

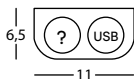

292.2H.MIX

KIT ELECTRICO MIXTO 1 BASE ENCHUFE + 1 USB
MIXED ELECTRIC SET 1 PLUG BASE + 1 USB
KIT ÉLECTRIQUE MIXTE 1 PRISE + 1 USB

0,01 m² / 1 Pack. / 1,5 kg

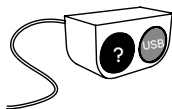

FÁCIL MONTAJE / EASY ASSEMBLY / MONTAGE FACILE

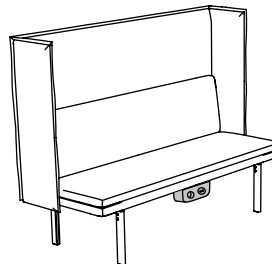
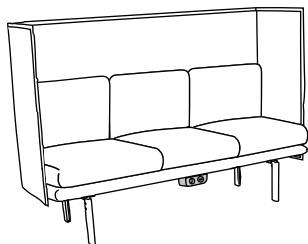

KIT ELÉCTRICO OPCIONAL / OPTIONAL ELECTRICAL KIT / KIT ÉLECTRIQUE EN OPTION



SELECCIONE EL ENCHUFE / SELECT AC SOCKET / SÉLECTIONNE LE PRISE

USB A + C 5A



EU



AU



GB



US*



* No disponemos de certificación para Japón.
Does not meet Japanese certification.
Ne répond pas à la certification du Japon.

Se suministrará el kit eléctrico con USB-A+C. Seleccione el enchufe internacional entre los cuatro tipos que se ilustran en el cuadro superior. La clavija de conexión a la red eléctrica viene definida por el enchufe internacional.

The electrical kit comes with USB-A+C. Choose the remaining AC socket for your country from the four types illustrated above. The plug will be the same type as the AC socket.

Le kit électrique est livré avec USB – A+C. Sélectionner la prise internationale qui vous convient entre les 4 types proposés, illustrés dans le cadre supérieur. La fiche de connexion au réseau électrique est définie par la prise internationale.

GB Socket: Fusing to enable compliance to BS6396.

Compliant with: BS5733-2010 and IEC60884-1

Certifications: UL962A/CSA22.2

CE marking: All units built with UK and European socket types are CE marked

REW by Rafa García, 2014

Sistema de asientos para descansar, comer o trabajar/ Sofa system for Resting, Eating or Working / Canape pour se reposer, manger ou travailler

ACABADOS / FINISHES / FINITIONS**PATAS / LEGS / PIED**FRESNO / ASH / FRÊNE
TINTES / STAINS / TEINTES

002 NATURAL

030 WENGUE
PLUS

003 NOGAL

004 CENIZA

006 ANTRACITA

055 SOMBRA

009 CEREZO

108 NEGRO

190 BLANCO

049 GRIS SEDA



180 CREMA

181 GRIS CUARZO

182 NUDE

057 CALABAZA

183 CASTAÑO

043 MANGO

184 CHAMPAGNE

189 LIMÓN

054 CURRY

185 PISCINA



186 AZAFATA

059 MENTA

187 ALPINO

041 MALAQUITA

188 MALVA

052 KLEIN

DESCARGAS

Más información, ficheros 3D, 2D, BIM, certificados de resistencia, calidad y medio ambientales disponibles en:

www.sancal.com/es/sofa-rew

DOWNLOADS

More information, 3D, 2D, BIM files as well as certificates for resistance, quality and the environment can be downloaded from:

www.sancal.com/en/sofa-rew

TÉLÉCHARGEMENTS

Plus d'informations, fichiers 3D, 2D, BIM, certificats de résistance, de qualité et environnementaux disponibles sur :

www.sancal.com/en/sofa-rew