

punt

ART, CRAFT & DESIGN



DUNE

TECHNICAL INFORMATION SHEET

DUNE

BY MONICA ARMANI, 2024

punt



PRODUCT TYPE

Armchair

Dune, designed by Monica Armani, is presented as a symbol of elegance inspired by nature. Its shapes refer to the majestic striations that sand generates in desert dunes, capturing the organic beauty and serenity of the landscape. A piece capable of bringing sophistication to any project and evoking a sense of perpetual movement thanks to its soft, curved lines.

TIPOLOGÍA DE PRODUCTO

Butaca

Dune, diseñado por Monica Armani, se presenta como un símbolo de elegancia inspirada en la naturaleza. Sus formas hacen referencia a las majestuosas estrías que la arena genera en las dunas del desierto, capturando la belleza orgánica y la serenidad del paisaje. Una pieza capaz de aportar sofisticación a cualquier proyecto y evocar una sensación de movimiento perpetuo gracias a sus líneas suaves y curvas.

DETAILS DETALLES



DUNE

BY MONICA ARMANI, 2024

punt

DIMENSIONS. DIMENSIONES

DUS100

Swivel base 
Base giratoria

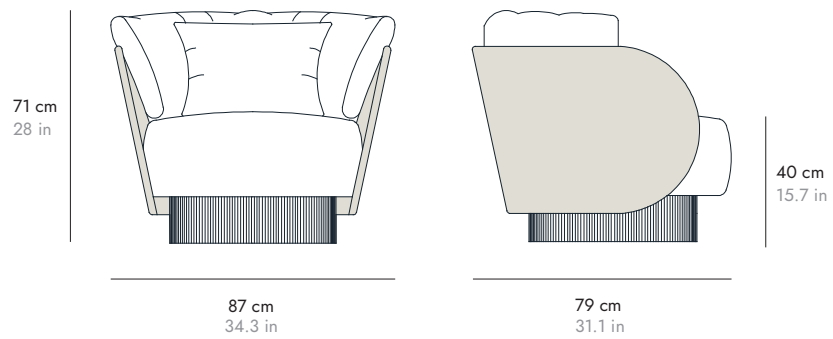

DUNE

BY MONICA ARMANI, 2024

punt

MATERIALS

Upholstery.
BS standard fireproof foam (33kg and 40kg).
Goose feather and siliconised fibre filled cushion.

Wood.
Backrest made of resistant curved plywood board with natural oak veneer.

Base.
Veneered plywood board with flexible textured lacquered MDF panel.

Wooden top Sobre de madera

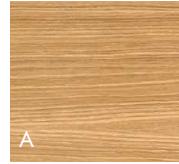

SUPER MATT OAK
ROBLE SÚPER MATE
CHENE SUPERMATE
SUPER MATT EICHE
ROVERE OPACO

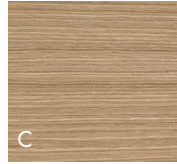

WHITENED OAK
ROBLE BLANQUEADO
CHENE BLANCHI
EICHE WEISS
ROVERE SBIANCATO



WALNUT STAINED OAK
ROBLE TEÑIDO NOGAL
CHENE TEINTÉ NOYER
EICHE NUSSBAUM
GEBEIZT
ROVERE TINTO NOLE

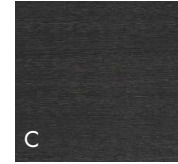

DARK GREY STAINED OAK
ROBLE TEÑIDO GRIS
CHENE TEINTE GRIS
DUNKELGRAU GEBEIZTE
EICHE
ROVERE TINTO GRIGIO SCURO

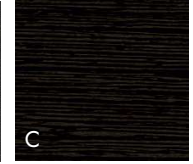

EBONY STAINED OAK
ROBLE TEÑIDO ÉBANO
CHENE TEINTÉ ÉBÔNE
EICHE GEBEIZT
EBENHOLZ
ROVERE TINTO ÉBANO

MATERIALES

Tapizados.
Espumas ignifugas normativa BS (33kg y 40kg).
Almohadón relleno de pluma de oca y fibra siliconada.

Madera.
Respaldo fabricado en resistente tablero curvado de contrachapado chapado en madera de roble natural.

Base.
Tablero de contrachapado chapado con panel flexible de MDF lacado texturizado.

Base Base



COPPER
COBRIZO
CUIVRE
KUPFER
RAME



GREEN FOREST
VERDE BOSQUE
FOREST VERT
WALDGRÜN
VERDE FORESTA



BLACK
NEGRO
NOIR
SCHWARZ
NERO



For special RAL colours, please consult Punt.

Para colores RAL especiales consultar con Punt.

Fabrics G2



RELATE 101

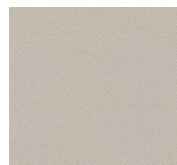

RELATE 201

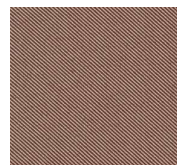

RELATE 341



TONAL 60122



TONAL 61179



TONAL 64211



CASERTA 04



CASERTA 15

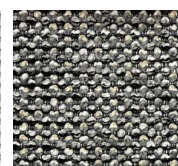

CASERTA 19



BACOLI 04

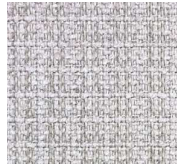

BACOLI 15



ODDI 09



MATIS 05



MATIS 07



SEVEN 59



SEVEN 05

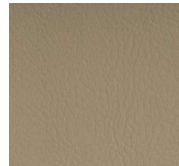

LEINEN 1049



SCHWARZ 9035

Fabrics G3



TEMPT 61169



TEMPT 61172



FIELD 232

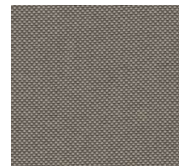

FIELD 242



REMUX 223



REMUX 233

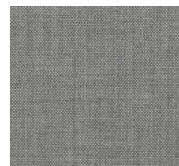

REMUX 123

Fabrics G4



FOCUS 60309



FOCUS 61242



SAVANNA 202



SAVANNA 122



SAVANNA 152

DUNE

BY MONICA ARMANI, 2024

punt

Fabrics G5



LAGUNA IVORY



LAGUNA SAND



LAGUNA STONE



LAGUNA CAMEL



LAGUNA COGNAC



LAGUNA BROWN



LAGUNA BLACK