

MITIS

Mario Ruiz. 2012

ESPAÑOL

Colección de mesas de aspecto sólido y detalles exquisitos tanto en el tablero como en sus patas ranuradas de tipo caballete.
Mesa apoyada sobre pies regulables.

MATERIALES

- Tablero MDF E1 (bajo contenido en formaldehído) aplacado en madera de roble o nogal natural con canto en madera maciza de 2 mm.
- Sobre de vidrio (10 mm).
- Patas en roble o nogal macizo.

ENGLISH

Tables with solid appearance and exquisite detailing in both table top and grooved legs.
Supplied with height adjustable feet.

MATERIALS

- E1 (low formaldehyde content) MDF fibreboard with oak or walnut veneer and 2 mm. solid edge.
- Glass top (10 mm).
- Solid oak or walnut legs.

FRANÇAIS

Collection de tables à l'aspect solide et aux détails exquis, tant dans le plateau que dans les pieds rainurés de style tréteau.
La table repose sur des pieds réglables.

MATÉRIAUX

- Panneau de particules MDF E1 (faible teneur en formaldéhyde) avec chant en bois massif de 2mm.
- Enveloppe en verre (10 mm).
- Pieds en chêne ou noyer massif.

DEUTSCH

Tisch Sammlung mit solider Erscheinung und erlesene Details in der Platte sowie im Bock-Stil geschlitzte Beine.
Der Tisch steht auf höhenverstellbaren Füßen.

MATERIALIEN

- Eiche oder Nussbaum Holzfurniere auf MDF E1 Platte (niedriger Inhalt vom Formaldehyd) mit Kanten aus 2 mm massive Holzleisten.
- Glashülle (10 mm).
- Massiv Eiche oder Nussbaum Beine.

ITALIANO

Collezione di tavoli dall'aspetto solido e con dettagli minuziosi sia nel pannello come nelle sue gambe tipo cavalletti con scanalature.

MATERIALI

- Pannello MDF E1 (a basso contenuto di formaldeide) placcato di legno di rovere o noce naturale con canto di legno massiccio di 2 mm.
- Busta di vetro (10 mm).
- Gambe in rovere o noce massiccio.

MITIS



MITIS / MITIS GLASS. MITIS / MITIS VIDRIO

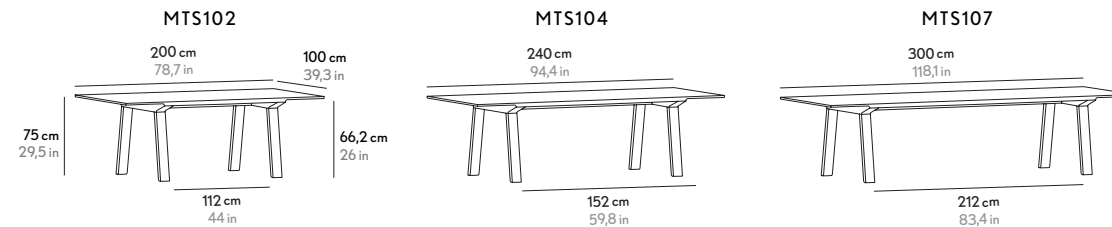

MITIS HIGH. MITIS ALTA



MITIS HIGH. MITIS ALTA

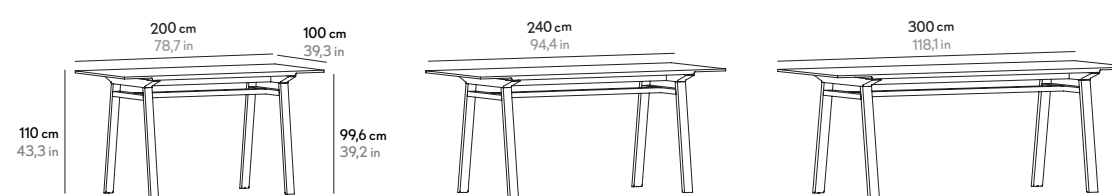

MITIS EXTREM. MITIS EXTREMO



MITIS EXTREM. MITIS EXTREMO

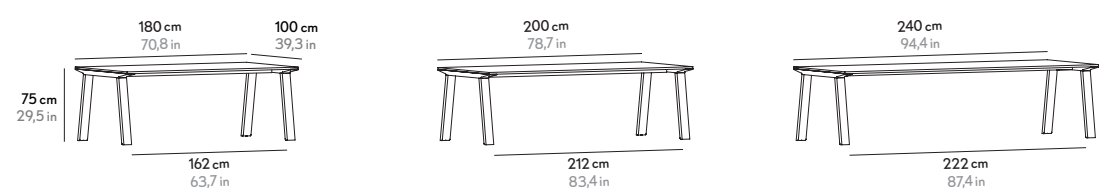

MITIS GLASS. MITIS VIDRIO



Special size. Tamaño especial

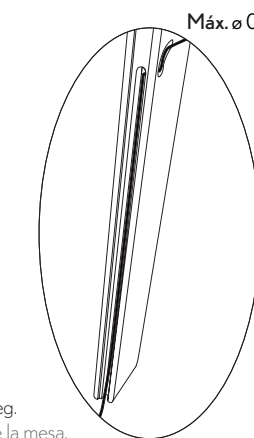

Máx. ø 0,7

Optional: grommet embedded on the table leg.
Opcional: pasacables integrado en la pata de la mesa.

FINISHES. ACABADOS

FRAME AND TOP. ESTRUCTURA Y SOBRE



TOP. TAPA SUPERIOR



DETAILS



COMPOSITIONS MITIS-HUG. COMPOSICIONES MITIS-HUG

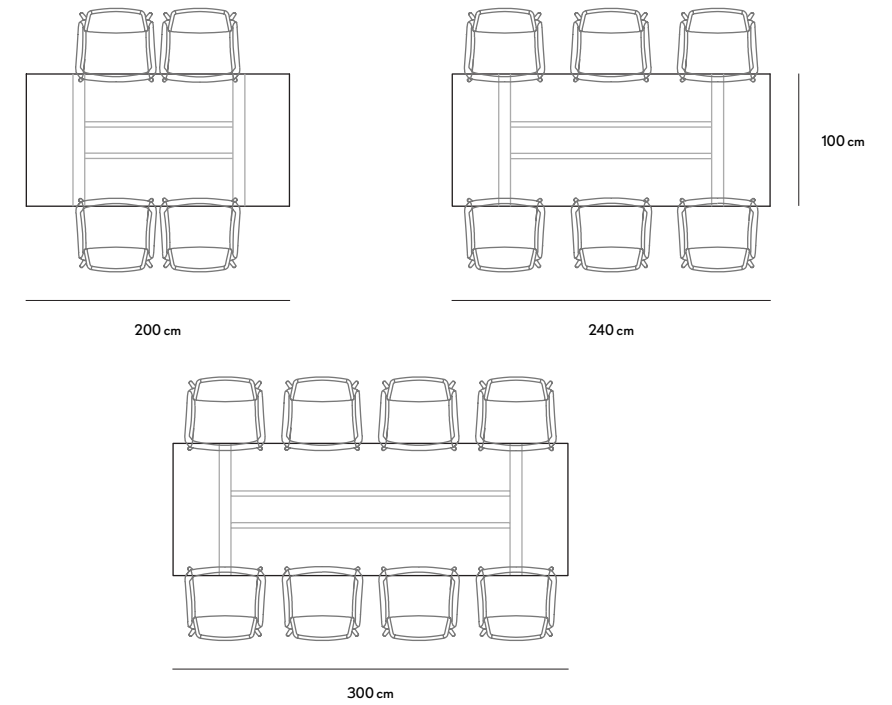

COMPOSITIONS MITIS EXTREM-HUG. COMPOSICIONES MITIS EXTREMO-HUG

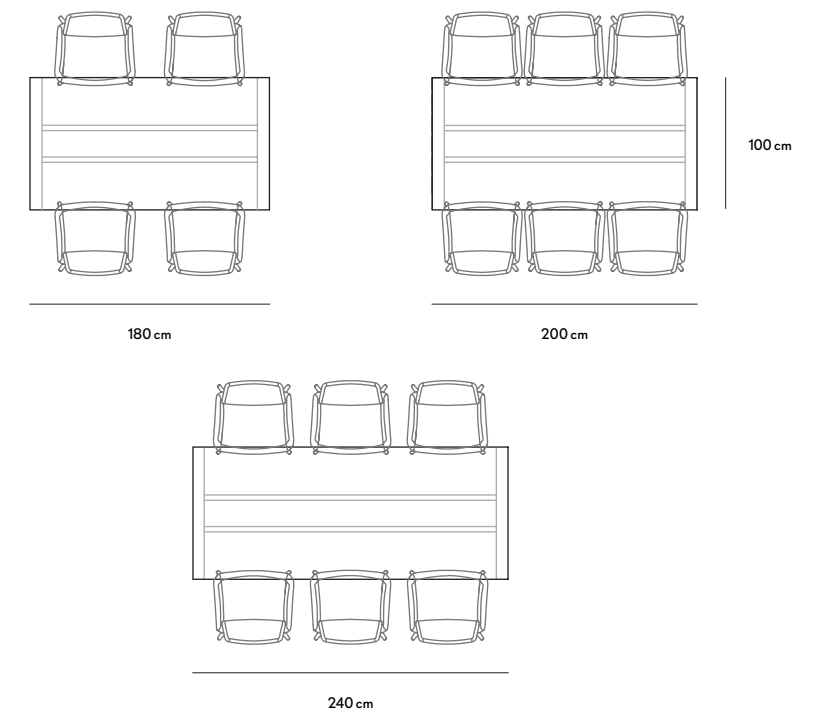

ACCESORIOS DE OFICINA

CIRCULAR GROMMET. PASACABLES CIRCULAR.

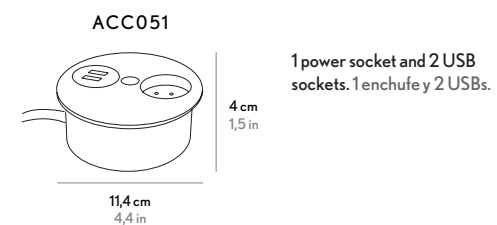
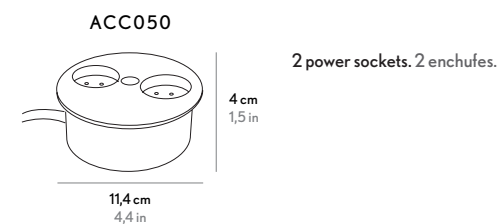

PIVOTAL GROMMET. PASACABLES PIVOTANTE.

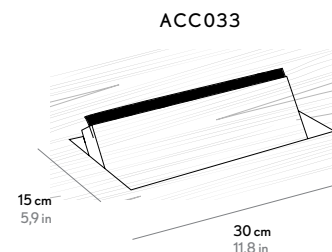
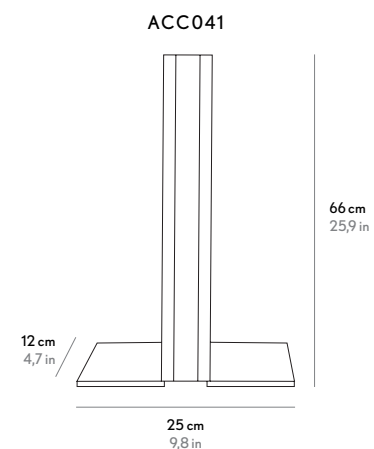
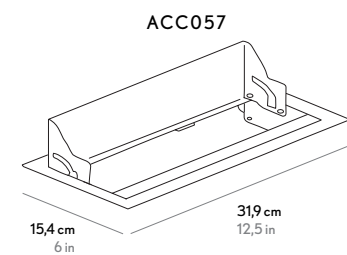
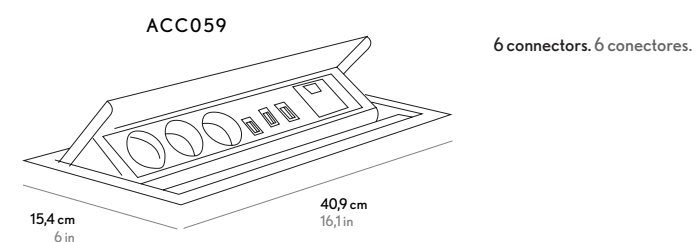
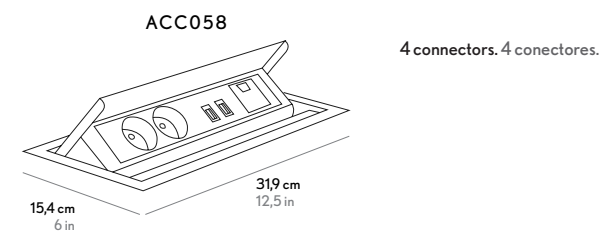

TABLE STAND. PIE DE MESA.



EMBEDDED MULTIPLE CONNECTION BOX. CAJA EMPOTRABLE DE CONEXIONES MÚLTIPLES.



GROMMET RUN CABLES AND ELECTRIFICATION. PASA CABLES Y ELECTRIFICACIÓN

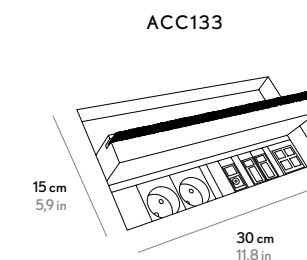
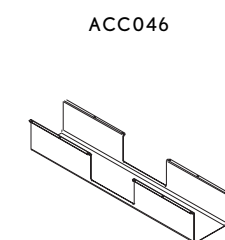
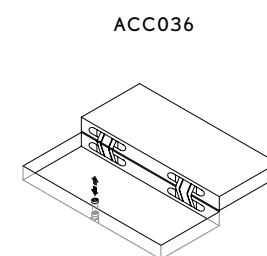

MACHINED HOLE MADE TO MEASURE. MECANIZADO MEDIDA PERSONALIZADA.

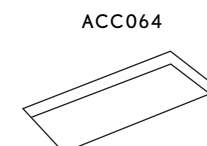

8 CM DIAMETER CIRCULAR MACHINED HOLE. MECANIZADO CIRCULAR DE DIÁMETRO 8CM.

