

BLTD - BLT

100%  
MADE IN  
ITALY

DESIGN  
Sebastian Herkner



EN: Coffee table with an aluminum structure, featuring a flower-shaped profile and marble, composite marble or solid laminate tops

IT: Tavolino con struttura in alluminio con profilo a forma di fiore e ripiano in marmo, agglomerato di marmo o stratificato

DE: Couchtisch mit Aluminiumgestell mit blumenförmigem Profil und Marmor-, Marmoragglomerat- oder Schichtplatte

FR: Table basse avec structure en aluminium avec profil en forme de fleur et plateau en marbre, marbre aggloméré ou stratifié

ES: Mesita con estructura en aluminio con perfil en forma de flor y sobre de mármol, aglomerado de mármol o compacto

mm - in

\* Table height increases of 1 cm for marble top versions

L'altezza del tavolo aumenta di 1 cm per le versioni con ripiano in marmo

• BLTD\_49X30\*

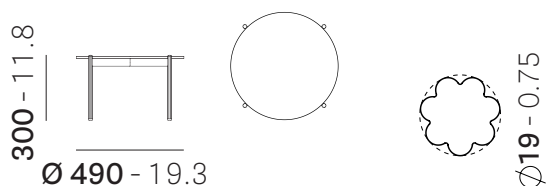

Disassembled  
Da assemblare

THICKNESS TOP

SOLID LAMINATE	MARBLE	COMPOSITE MARBLE
10mm - 0.39"	12mm - 0.47"	20mm - 0.79"
		12mm - 0.47"

• BLTD\_89X30\*

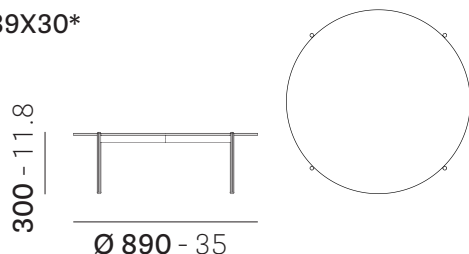

Disassembled  
Da assemblare

THICKNESS TOP

SOLID LAMINATE	MARBLE	COMPOSITE MARBLE
10mm - 0.39"	12mm - 0.47"	20mm - 0.79"
		12mm - 0.47"

• BLT\_50X35X30\*



Disassembled  
Da assemblare

THICKNESS TOP

SOLID LAMINATE	MARBLE	COMPOSITE MARBLE
10mm - 0.39"	12mm - 0.47"	20mm - 0.79"
		12mm - 0.47"

• BLT\_90X60X30\*



Disassembled  
Da assemblare

THICKNESS TOP

SOLID LAMINATE	MARBLE	COMPOSITE MARBLE
10mm - 0.39"	12mm - 0.47"	20mm - 0.79"
		12mm - 0.47"

Reproduction of this document is strictly prohibited without prior written authorisation from Pedrali SpA. Sizes, weights and finishes may change without previous notice. È vietata la riproduzione del seguente documento senza previa autorizzazione scritta da parte di Pedrali SpA. Dimensioni, pesi e finiture possono variare senza alcun preavviso.

ST\_BLUME\_BLT\_BLTD\_2023.0

BLTD - BLT

DESIGN  
Sebastian Herkner

• BLT\_69X69X30\*

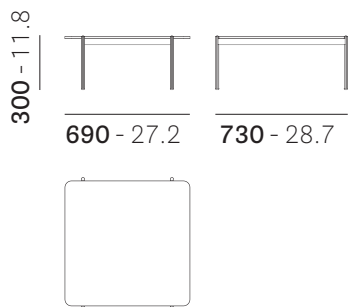

Disassembled  
Da assemblare

THICKNESS TOP

SOLID LAMINATE		MARBLE		COMPOSITE MARBLE	
10mm - 0.39"	12mm - 0.47"	20mm - 0.79"	12mm - 0.47"	12mm - 0.47"	12mm - 0.47"

• BLT\_99X99X30\*

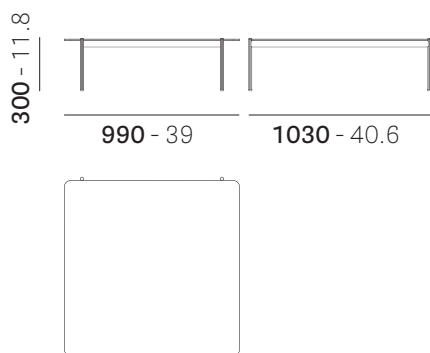

Disassembled  
Da assemblare

THICKNESS TOP

SOLID LAMINATE		MARBLE		COMPOSITE MARBLE	
10mm - 0.39"	12mm - 0.47"	20mm - 0.79"	12mm - 0.47"	12mm - 0.47"	12mm - 0.47"

• BLT\_100X25X30\*

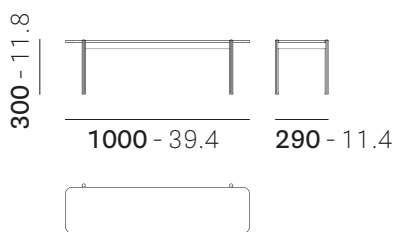

Disassembled  
Da assemblare

THICKNESS TOP

SOLID LAMINATE		MARBLE		COMPOSITE MARBLE	
10mm - 0.39"	12mm - 0.47"	20mm - 0.79"	12mm - 0.47"	12mm - 0.47"	12mm - 0.47"

• BLTD\_49X37\*

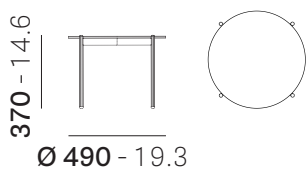

Disassembled  
Da assemblare

THICKNESS TOP

SOLID LAMINATE		MARBLE		COMPOSITE MARBLE	
10mm - 0.39"	12mm - 0.47"	20mm - 0.79"	12mm - 0.47"	12mm - 0.47"	12mm - 0.47"

Reproduction of this document is strictly prohibited without prior written authorisation from Pedrali SpA. Sizes, weights and finishes may change without previous notice.  
 È vietata la riproduzione del seguente documento senza previa autorizzazione scritta da parte di Pedrali SpA. Dimensioni, pesi e finiture possono variare senza alcun preavviso.

ST\_BLUME\_BLT\_BLTD\_2023.0

BLTD - BLT

DESIGN  
Sebastian Herkner

• BLTD\_89X37\*

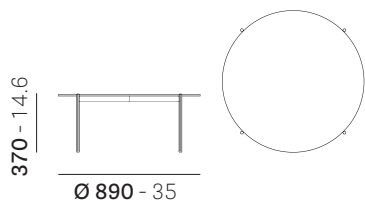

Disassembled  
Da assemblare

THICKNESS TOP

SOLID LAMINATE	MARBLE	COMPOSITE MARBLE
10mm - 0.39"	12mm - 0.47"	20mm - 0.79"
		12mm - 0.47"

• BLT\_50X35X37\*

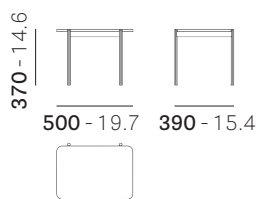

Disassembled  
Da assemblare

THICKNESS TOP

SOLID LAMINATE	MARBLE	COMPOSITE MARBLE
10mm - 0.39"	12mm - 0.47"	20mm - 0.79"
		12mm - 0.47"

• BLT\_90X60X37\*

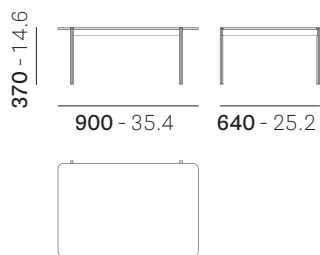

Disassembled  
Da assemblare

THICKNESS TOP

SOLID LAMINATE	MARBLE	COMPOSITE MARBLE
10mm - 0.39"	12mm - 0.47"	20mm - 0.79"
		12mm - 0.47"

• BLT\_69X69X37\*

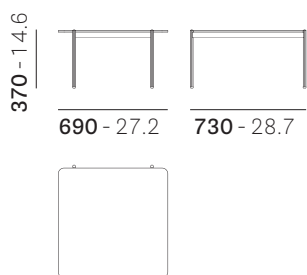

Disassembled  
Da assemblare

THICKNESS TOP

SOLID LAMINATE	MARBLE	COMPOSITE MARBLE
10mm - 0.39"	12mm - 0.47"	20mm - 0.79"
		12mm - 0.47"

• BLT\_99X99X37\*

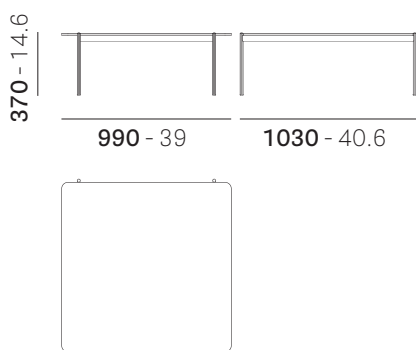

Disassembled  
Da assemblare

THICKNESS TOP

SOLID LAMINATE	MARBLE	COMPOSITE MARBLE
10mm - 0.39"	12mm - 0.47"	20mm - 0.79"
		12mm - 0.47"

Reproduction of this document is strictly prohibited without prior written authorisation from Pedrali SpA. Sizes, weights and finishes may change without previous notice. È vietata la riproduzione del seguente documento senza previa autorizzazione scritta da parte di Pedrali SpA. Dimensioni, pesi e finiture possono variare senza alcun preavviso.

ST\_BLUME\_BLT\_BLTD\_2023.0

BLTD - BLT

DESIGN  
Sebastian Herkner

• BLT\_100X25X37\*

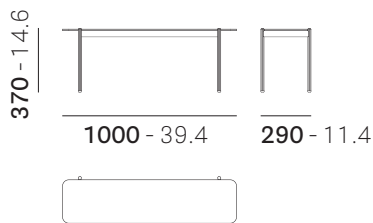

Disassembled  
Da assemblare

THICKNESS TOP

SOLID LAMINATE	MARBLE	COMPOSITE MARBLE
10mm - 0.39"	12mm - 0.47"	20mm - 0.79"
		12mm - 0.47"

• BLTD\_49X45\*

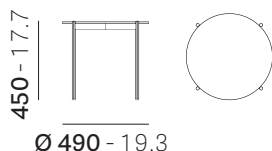

Disassembled  
Da assemblare

THICKNESS TOP

SOLID LAMINATE	MARBLE	COMPOSITE MARBLE
10mm - 0.39"	12mm - 0.47"	20mm - 0.79"
		12mm - 0.47"

• BLTD\_89X45\*

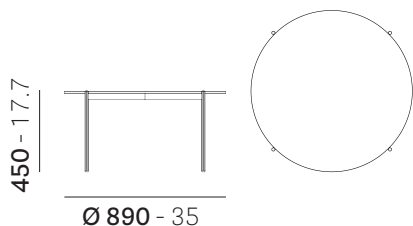

Disassembled  
Da assemblare

THICKNESS TOP

SOLID LAMINATE	MARBLE	COMPOSITE MARBLE
10mm - 0.39"	12mm - 0.47"	20mm - 0.79"
		12mm - 0.47"

• BLT\_50X35X45\*

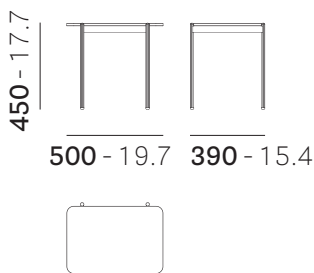

Disassembled  
Da assemblare

THICKNESS TOP

SOLID LAMINATE	MARBLE	COMPOSITE MARBLE
10mm - 0.39"	12mm - 0.47"	20mm - 0.79"
		12mm - 0.47"

• BLT\_90X60X45\*

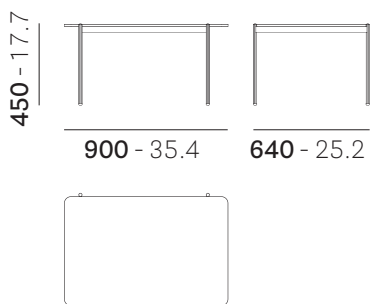

Disassembled  
Da assemblare

THICKNESS TOP

SOLID LAMINATE	MARBLE	COMPOSITE MARBLE
10mm - 0.39"	12mm - 0.47"	20mm - 0.79"
		12mm - 0.47"

Reproduction of this document is strictly prohibited without prior written authorisation from Pedrali Spa. Sizes, weights and finishes may change without previous notice.  
 È vietata la riproduzione del seguente documento senza previa autorizzazione scritta da parte di Pedrali Spa. Dimensioni, pesi e finiture possono variare senza alcun preavviso.

ST\_BLUME\_BLT\_BLTD\_2023.0

BLTD - BLT

DESIGN  
Sebastian Herkner

• BLT\_69X69X45\*

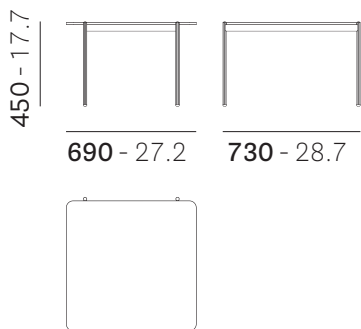

Disassembled  
Da assemblare

THICKNESS TOP

SOLID LAMINATE		MARBLE		COMPOSITE MARBLE	
10mm - 0.39"	12mm - 0.47"	20mm - 0.79"	12mm - 0.47"		

• BLT\_99X99X45\*

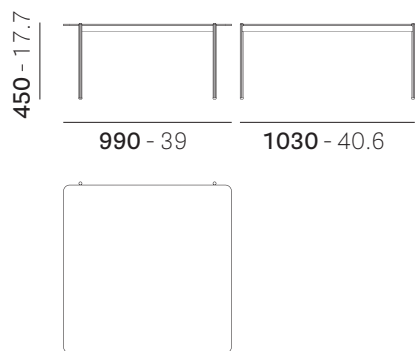

Disassembled mc 0,168  
Da assemblare ft³ 5.9

SOLID LAMINATE		MARBLE		COMPOSITE MARBLE	
10mm - 0.39"	12mm - 0.47"	20mm - 0.79"	12mm - 0.47"		
kg 18,43	kg 21,08	kg 65,44	kg 43,93		
lb 40.6	lb 46.5	lb 144.3	lb 96.8		

• BLT\_100X25X45\*

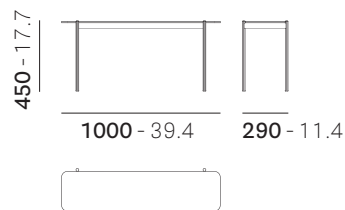

Disassembled  
Da assemblare

THICKNESS TOP

SOLID LAMINATE		MARBLE		COMPOSITE MARBLE	
10mm - 0.39"	12mm - 0.47"	20mm - 0.79"	12mm - 0.47"		

Reproduction of this document is strictly prohibited without prior written authorisation from Pedrali SpA. Sizes, weights and finishes may change without previous notice.  
 È vietata la riproduzione del seguente documento senza previa autorizzazione scritta da parte di Pedrali SpA. Dimensioni, pesi e finiture possono variare senza alcun preavviso.

ST\_BLUME\_BLT\_BLTD\_2023.0

BLTD - BLT

DESIGN  
Sebastian Herkner

## MATERIALS

Materiali  
Materialien  
Matériaux  
Materiales

### • TOP - RIPIANO - TISCHPLATTE - PLATEAU - SOBRE

#### EN: Solid laminate top

IT: Ripiano in stratificato  
DE: Kompakt-Tischplatte  
FR: Plateau stratifiés  
ES: Sobre compacto

### TOP FINISH - FINITURA RIPIANO - AUSFÜHRUNG DER TISCHPLATTE - FINITION PLATEAU - ACABADO SOBRE



CFC\_BI

TOP / RIPIANO / TISCHPLATTE / PLATEAU / SOBRE

**10 mm thickness** / Spessore 10 mm / Stärke 10 mm / Épaisseur 10 mm / Espesor 10 mm

**Flat edge** / Bordo piatto / Flache Kante / Chant plat / Canto rec

**White core** / Anima bianca / Weißer Kern / Coeur blanc / Alma blanco



FNP\_NE\* FNP\_3452\*

#### \*Anti-fingerprint finish

Finitura anti-impronta

TOP / RIPIANO / TISCHPLATTE / PLATEAU / SOBRE

**10 mm thickness** / Spessore 10 mm / Stärke 10 mm / Épaisseur 10 mm / Espesor 10 mm

**Flat edge** / Bordo piatto / Flache Kante / Chant plat / Canto rect

**Black core** / Anima nera / Schwarzer kern / Coeur noir / Alma negra



FNP\_3455\*

#### \*Anti-fingerprint finish

Finitura anti-impronta

TOP / RIPIANO / TISCHPLATTE / PLATEAU / SOBRE

**10 mm thickness** / Spessore 10 mm / Stärke 10 mm / Épaisseur 10 mm / Espesor 10 mm

**Flat edge** / Bordo piatto / Flache Kante / Chant plat / Canto rect

**White core** / Anima bianca / Weißer Kern / Coeur blanc / Alma blanco

• **TOP - RIPIANO - TISCHPLATTE - PLATEAU - SOBRE**

**EN: Marble top**

IT: Ripiano in marmo  
DE: Marmor-Tischplatte  
FR: Plateau en marbre  
ES: Sobre de mármol

**TOP FINISH - FINITURA RIPIANO - AUSFÜHRUNG DER TISCHPLATTE - FINITION PLATEAU - ACABADO SOBRE**

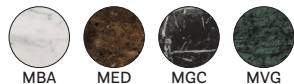

**TOP / RIPIANO / TISCHPLATTE / PLATEAU / SOBRE**

**20 mm thickness** / Spessore 20 mm / Stärke 20 mm / Épaisseur 20 mm / Espesor 20 mm  
**Flat edge** / Bordo piatto / Flache Kante / Chant plat / Canto rec

• **TOP - RIPIANO - TISCHPLATTE - PLATEAU - SOBRE**

**EN: Compite marble top**

IT: Ripiano in agglomerato di marmo  
DE: Marmor-Konglomerat  
FR: Plateau en marbre aggloméré  
ES: Sobre de mármol aglomerado

**TOP FINISH - FINITURA RIPIANO - AUSFÜHRUNG DER TISCHPLATTE - FINITION PLATEAU - ACABADO SOBRE**

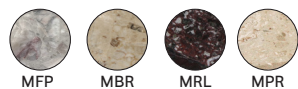

**TOP / RIPIANO / TISCHPLATTE / PLATEAU / SOBRE**

**12 mm thickness** / Spessore 12 mm / Stärke 12 mm / Épaisseur 12 mm / Espesor 12 mm  
**Flat edge** / Bordo piatto / Flache Kante / Chant plat / Canto rec

• **FRAME - TELAIO - STRUKTUR - STRUCTURE - ARMAZÓN**

**EN: Legs in extruded anodized aluminum Ø19 mm, with a flower shaped section, top support in steel tube sized 35x15 mm, black powder coated**

IT: Gambe in estruso di alluminio anodizzato con sezione a fiore Ø19 mm, supporto ripiano in tubo 35x15 mm in acciaio, verniciato a polvere nero  
DE: Beine aus druckgussgegossenem Aluminium in Blumenform Ø19 mm, Obere Stütze aus Stahlrohr mit den Maßen 35x15 mm, schwarz pulverbeschichtet  
FR: Pieds en aluminium extrudé anodisé Ø19 mm, section à fleur, support de plateau en tube acier 35x15 mm époxy noir  
ES: Patas de aluminio extruido anodizado de Ø19 mm, con sección de flor, soporte del sobre en tubo de 35x15 mm en acero, pintado en polvo negro

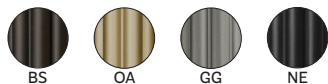

**EN: For more information see finishing legend on the website**

IT: Per maggiori informazioni vedere legenda finiture sul sito web

• **FEET - PIEDINI - GLEITER - PATINS - TACOS**

**EN: In polyethylene, black**

IT: In polietilene, nero  
DE: Aus Polyethylen, schwarz  
FR: En polyéthylène, noir  
ES: De polietileno, negro

### REGULATIONS AND CERTIFICATES

Normative e Certificazioni  
Bestimmungen und Zertifikat  
Normatives et certifications  
Normativas y certificados

### • ENVIRONMENTAL IMPACT - IMPATTO AMBIENTALE - UMWELTBELASTUNG - IMPACT SUR L'ENVIRONNEMENT - IMPACTO AMBIENTAL

MATERIAL Materiale	WEIGHT (Kg) Peso (Kg)	% ON TOTAL ITEM % su tot articolo	MATERIAL RECYCLABILITY Riciclabilita' del materiale	% RECYCLED AT ORIGIN % riciclato all'origine	% RECYCLABLE END OF PRODUCT LIFE % riciclabile fine vita prodotto
Steel Acciaio	3,93	6,01	YES	33,2	100
Extruded aluminium Alluminio estruso	1,12	1,71	YES	0	100
Zamak Zama	0,18	0,27	YES	50	100
Polypropylene Polipropilene	0,01	0,01	YES	0	100
Solid laminate Stratificato	6,41	9,79	NO	0	0
Marble Stratificato	53,8	82,21	YES	0	100
<b>TOTAL TOTALE</b>	<b>65,44 Kg</b>	<b>--</b>	<b>--</b>	<b>2,1 %</b>	<b>90,2 %</b>

EN: Percentages referred to BLT\_99X99X45 (Marble)

IT: Percentuali riferite al BLT\_99X99X45 (Marmo)

### • COMPANY CERTIFICATIONS - CERTIFICAZIONI AZIENDALI - UNTERNEHMENSZERTIFIZIERUNGEN - CERTIFICATIONS D'ENTREPRISE - CERTIFICACIONES DE LA EMPRESA

ISO 14001  
Environmental management system  
Sistema di gestione ambientale



ISO 9001  
Quality management system  
Sistema di gestione della qualità

